

**6,95" TFT/LCD**  
**TOUCH SCREEN**  
1024 x 600



## VM002

MEDIASTATION ANDROID con MONITOR TFT/LCD 6,95"  
TOUCH SCREEN, UNIVERSALE 2 DIN

UNIVERSAL 2 DIN ANDROID MEDIASTATION  
with TOUCH SCREEN TFT/LCD 6,95" DISPLAY

MEDIASTATION ANDROID avec ECRAN TFT/LCD 6,95"  
TOUCH SCREEN, UNIVERSAL 2 DIN

MEDIASTATION ANDROID mit MONITOR TFT/LCD 6,95"  
TOUCH SCREEN, UNIVERSAL 2 DIN

MEDIASTATION ANDROID DAB + UNIVERSAL 2 DIN  
con PANTALLA TÁCTIL TFT / LCD 6,95"

Manuale istruzioni **IT**

Instructions manual **EN**

Notice de montage et d'emploi **FR**

Gebrauchsanweisungen **DE**

Manual de instrucciones **ES**



## Precauzioni • Warnings • Précautions • Vorsicht • Precauciones

---

**IT** • Per l'installazione rivolgersi al personale tecnico qualificato. • Usare solo con impianto elettrico a 12V DC con negativo a massa. • Scollegare il terminale negativo della batteria del veicolo quando si effettuano le connessioni dell'apparecchio. • Quando si sostituisce il fusibile, utilizzarne uno con lo stesso valore di amperaggio. • Non aprire l'unità e non tentare di ripararla, consultare il proprio rivenditore o personale tecnico qualificato. • Assicurarsi che oggetti estranei non entrino all'interno dell'apparecchio, potrebbero causare malfunzionamenti, generare cortocircuiti elettrici o un'esposizione rischiosa ai raggi laser se presenti. • Accendere l'apparecchio solo quando la temperatura dell'abitacolo è nella norma. • Mantenere un volume di ascolto che permetta di udire i suoni provenienti dall'esterno del veicolo (clacson, sirene, etc. ...). • Non collegare alcun cavo in luoghi dove potrebbe ostacolare il funzionamento dei dispositivi di sicurezza dell'auto.

**GB** • Installation to be carried out by trained technical personnel • Make sure you have 12V DC, with negative-pole to mass • First disconnect negative-pole of the car-battery, then effect car-radio connections • When replacing fuse, always use fuse with same Ampere-value • Never open the unit, nor try to repair yourself. Always ask your Retailer or authorized technical staff • Make sure that no foreign objects fall into the unit, they would cause malfunctions, short-circuits or exposure to dangerous laser-rays • When switching-on, make sure that temperate inside passenger-compartment is at a normal level • Choose a listening-Volume which will allow you to hear external noises (car-horn, sirens etc.) • When placing the cables, keep away from all car security-devices.

**FR** • Se servir du personnel technique qualifié pour l'installation. • Utiliser uniquement dans des installations électriques à 12V DC avec négatif à masse. • Débrancher le terminal négatif de la batterie lorsqu'on fait les connexions de l'appareil. • Quand on remplace un fusible, se servir d'un autre ayant le même ampérage. • Ne pas ouvrir l'appareil pour essayer de le réparer, contacter votre revendeur ou un personnel technique qualifié • Eviter que des corps étrangers entrent dans l'appareil, car ils peuvent provoquer des mauvais fonctionnements, des courts circuits; éviter aussi l'exposition risquée aux rayons laser si présents. • Allumer l'appareil seulement lorsque la température interne du véhicule est dans la norme • Tenir le volume à un niveau permettant d'écouter les sons en provenance de l'extérieur du véhicule (Klaxon, sirène etc....) • Ne brancher aucun câble dans des endroits pouvant causer les obstacles au fonctionnement des dispositifs de sécurité du véhicule.

**DE** • Die Installation muss durch technische Fachkräfte vorgenommen werden • Nur bei 12V DC verwenden, mit Negativ-Pol zur Masse • Erst den Negativ-Pol der Auto-Batterie abtrennen, dann die Radio-Anschlüsse herstellen • Beim Auswechseln, immer Sicherungen derselben Ampere-Stärke verwenden • Nie versuchen, das Gerät zu öffnen oder eigenhändig zu reparieren. Immer den Händler bzw. technische Fachkräfte zu Rate ziehen • Sicherstellen, dass keinerlei Fremdkörper in das Gerät eindringen können. Diese würden Betriebsstörungen, Kurzschlüsse oder die Entfaltung gefährlicher Laser-Strahlen verursachen • Gerät nur dann einschalten, wenn die Temperatur im Wagen-Innenraum auf normalem Niveau ist • Lautstärke so einstellen, dass externe Geräusche (Hupe, Sirenen etc.) noch hörbar sind • Kabel fernhalten von allen Sicherheits-Geräten des Wagens.

**ES** • Para la instalación, contactar exclusivamente con empresas especializadas y personal técnicamente cualificado. • Usar solo en vehículos con alimentación de 12V DC y negativo a masa. • Desconectar el terminal negativo de la batería del vehículo cuando se efectúan las conexiones del aparato. • Cuando se sustituya el fusible, utilizar exclusivamente fusibles con el mismo amperaje. • No abrir la unidad y no intentar repararla, consultar al revendedor o personal técnico cualificado. • Asegurarse de que no entren objetos extraños en su interior, ya que impediría el buen funcionamiento, generar cortocircuitos eléctricos, además se corre el riesgo de una exposición muy perjudicial a los rayos laser, si están presentes • Encender el aparato solo cuando la temperatura del habitáculo se haya normalizado. • Mantener un volumen de escucha tal que nos permita escuchar los sonidos del ambiente circunstante. (Claxon, sirenas) • No conectar ningún cable en lugares que puedan obstaculizar el funcionamiento de los dispositivos de seguridad del coche.

Manuale istruzioni • Instructions manual

# VM002

IT

EN

## Caratteristiche tecniche • Technical features

---

### IT

- Digital TFT/LCD monitor 6,95" wide - Touch Screen
- Risoluzione monitor 1024x600 pixel
- Riproduzione video 1080P
- Sistema operativo Android 9.0
- Vivavoce Bluetooth Con Microfono Esterno (SUPPORTO iOS, A2DP, GESTIONE RUBRICA)
- Processore 4 core 1.2 GHZ RAM 2 GB
- Memoria interna tipo NAND 16 GB
- Sintonizzatore Radio FM-AM-RDS-EON PLL con 18 stazioni memorizzabili in FM e 12 in AM

### EN

- Digital TFT/LCD monitor 6,95" wide - Touch Screen
- Resolution 1024x600 pixel
- 1080P multimedia playback
- OS Android 9.0
- Handsfree with external microphone (iOS - A2DP - SUPPORT - PHONEBOOK)
- Processor 4 core 1.2 GHZ RAM 2 GB
- NAND Flash memory 16 GB
- Tuner FM-AM-RDS-EON PLL memory for 18 FM and 12 AM stations

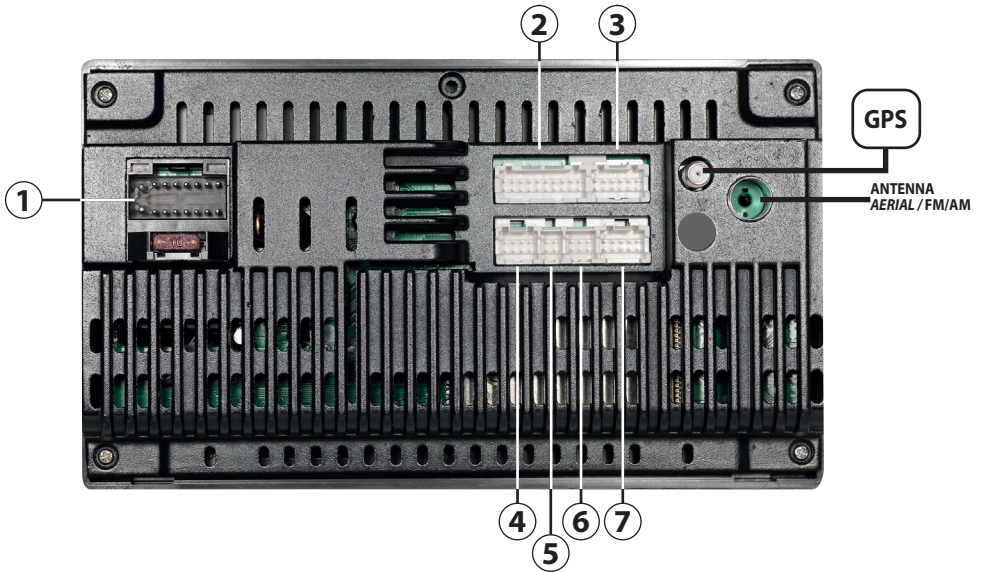

**1** ALIMENTAZIONE - USCITE ALTOPARLANTI / POWER-SUPPLY - SPEAKERS OUTPUT SWC\*

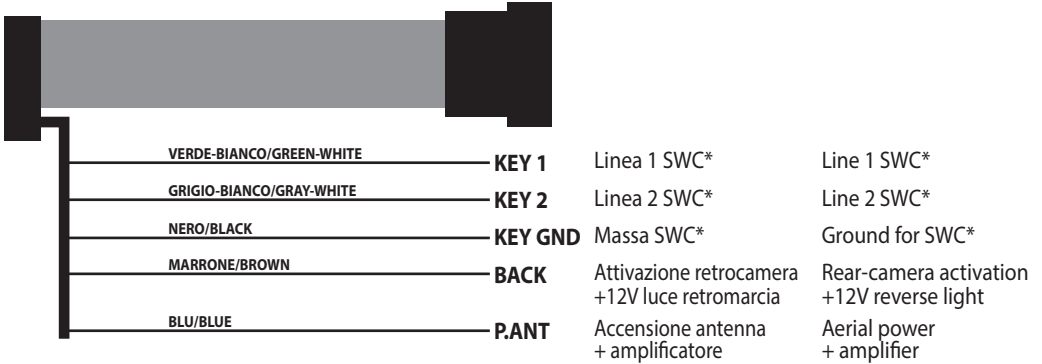

\*SWC: Comandi al Volante / Steering Wheel Commands

**2** USCITE PRE-AMP PRE-AMP OUTPUT

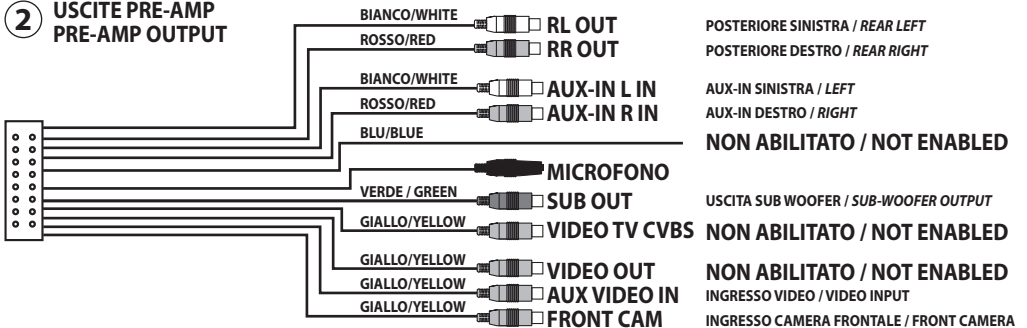

③-④ **NON ABILITATO / NOT ENABLED**

⑤ **PRESE USB / USB PLUG-IN**  USB USB

⑥

⑦ **FRENO A MANO - INGRESSO RETROCAMERA / BRAKE - REAR-CAMERA INPUT**

	VERDE-BIANCO/GREEN-WHITE	<b>BRAKE</b>	Freno a mano (collegamento obbligatorio)	Hand-Brake (connection absolutely necessary)
	BIANCO/WHITE	<b>NON ABILITATI / NOT ENABLED</b>		
	GRIGIO/GRAY	<b>CAM VIDEO IN</b>	Ingresso retrocamera	Rear-Camera input
	GRIGIO/GRAY	<b>CAM VIDEO IN</b>		

# CONNESSIONI COMANDI AL VOLANTE RESISTIVI

## RESISTIVE SWC CONNECTIONS

**IT** - Per i collegamenti al connettore auto originale utilizzare gli schemi presenti sul manuale istruzioni dell'interfaccia 04083. Per le auto con la linea CAN è necessario collegare l'interfaccia comandi al volante CAN-BUS.

**EN** - When connecting to the original car-connector, please refer to the connection-schemes shown in the Instructions Manual of Interface 04083.

For cars having CAN line, it is necessary to connect the steering wheel control interface.

CAVI / CABLES VM002		CAVI / CABLES 04083
KEY 1	>	VERDE-BIANCO / GREEN-WHITE
KEY 2	>	GRIGIO-BIANCO / GREY-WHITE
KEY GND	>	NERO / BLACK

### CORRISPONDENZA COLORE CAVI COMBINATION OF CABLE-COLOURS

### ESEMPIO / EXAMPLE

SCHEMA COLLEGAMENTI NEL MANUALE ISTRUZIONI 04083  
CONNECTION DIAGRAM IN THE INSTRUCTION MANUAL 04083

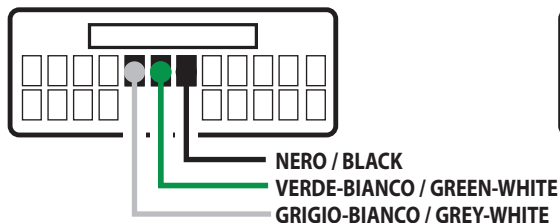

PROGRAMMAZIONE AUTORADIO Vedi pag. 20

SCHEMA COLLEGAMENTI DEL VM002  
CONNECTION DIAGRAM OF VM002

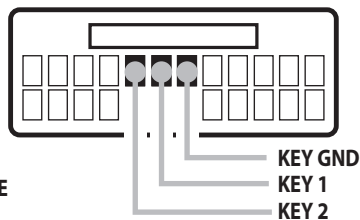

PROGRAMMING THE CAR-RADIO page 20



**IT**











1. Non attivo
2. Tasto RESET
3. Tasto MUTE (pressione breve)  
Accensione/Spengimento (pressione 3 secondi)
4. Menu principale
5. Torna alla funzionalità precedente
6. Navigazione
- 7 Volume + /Volume -

**EN**

1. Not active
2. RESET key
3. MUTE key (briefly pressing)  
ON /OFF (Press for 3 seconds)
4. Main menu
5. Back to previous function
6. Navigation
- 7 Volume + /Volume -

**IT**

All'accensione il VM002 avvia il menu principale .  
È possibile personalizzare questo menu con le icone delle APP installate.

-  Torna al menu principale.
-  Regolazione Volume -
-  Regolazione Volume +
-  Accende/spegne illuminazione LCD
-  Equalizzatore audio
-  Posizione GPS riconosciuta
-  WI-FI attivato e agganciato
-  Bluetooth acceso
-  Visualizzazione di tutte le APP aperte
-  Torna alla funzionalità precedente

**EN**

When the VM002 is turned on, the main menu starts automatically. You can customize this menu with the desired installed APP icons.

-  Back to main menu
-  Volume Control -
-  Volume Control +
-  Turns LCD light on/off
-  Radio equalizer
-  Real GPS position fixe
-  WI-FI paired with signal power
-  Bluetooth ON
-  Show open APPs
-  Back to previous function



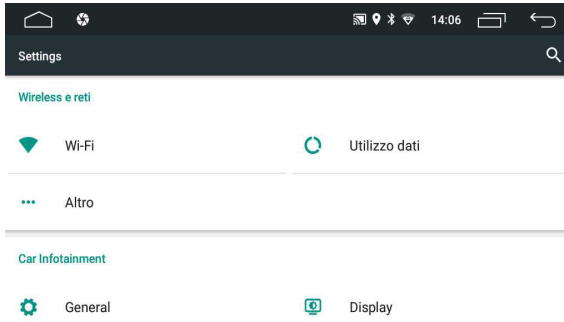

## IT

Premere l'icona  "SETTING" dal menu principale per accedere alle impostazioni di sistema Android.

- **WIRELESS E RETI:** Attiva/disattiva il Wi-Fi e permette di accoppiarsi ad un router raggiungibile. Modifica le impostazioni dell'APN.
- **CAR INFOTAINMENT:** Permette di modificare i settaggi del display, generali, imposta i volumi e l'equalizzatore, modifica lo stato del Bluetooth, accede alla memorizzazione dei comandi al volante, e visualizza informazioni del software.
- **DISPOSITIVO:** Visualizza spazio della memoria interna e gestisce la APP installate
- **PERSONALI:** Crea e visualizza impostazioni account e seleziona la lingua del sistema
- **SISTEMA:** Regolazione orario e data. Visualizzazione delle informazioni hardware e software del sistema Android.









## EN

Press the icon  "SETTING" from the main menu to enter the Android system settings.

- **WI-FI :** Switches ON/OFF the wireless connection and allows you to pair with a reachable router. Changes APN settings.
- **CAR INFOTAINMENT:** Allows you to change the display settings, general, sets the volumes and the equalizer, changes the status of Bluetooth, enters to the memorization of the steering wheel commands, and displays information about the software.
- **DEVICE :** Internal memory status and APPs management
- **PERSONAL:** Account access and languages settings
- **SYSTEM:** Date & Time setting and Android hardware and software information.









**IT**

Premere sul touch screen l'icona  del menù APP si accede la funzione riproduzione RADIO.

-  Torna al menu principale.
-  Visualizza le APP aperte in background
-  Passa alla schermata HOME
-  Apre il menu settaggi funzioni RDS
- REGION** ON/OFF
- PI** SOUND/MUTE
- TA** Attiva/Disattiva ricezione informazioni traffico
- RETUNE** Short/Long
- AF** Attiva/Disattiva frequenza alternativa RDS
- FM/AM** Banda radio
-  Ricerca automatica e manuale stazione  
Indietro/Avanti
-  Scansioni stazioni
-  Equalizzatore
-  Interrompe la funzione RADIO e torna al menù principale
-  Apre la barra di selezione valore volume

**EN**

By pressing the icon  from the touchscreen of the APP menu, you will enter the RADIO playback function.

-  Back to main menu
-  Shows the APPs open in background
-  Switches to HOME screen
-  RDS Opens the RDS functions settings menu
- REGION** REGION: ON/OFF
- PI** SOUND/MUTE
- TA** Switch ON/OFF traffic information channel
- RETUNE** Short/Long
- AF** Switches ON/OFF alternative frequency
- FM/AM** Radio-Band
-  Autom. manual stations research  
Backward / Forward
-  Stations scanning
-  Equalizer
-  Stops the RADIO function and returns to the main menu
-  Opens the volume value selection bar

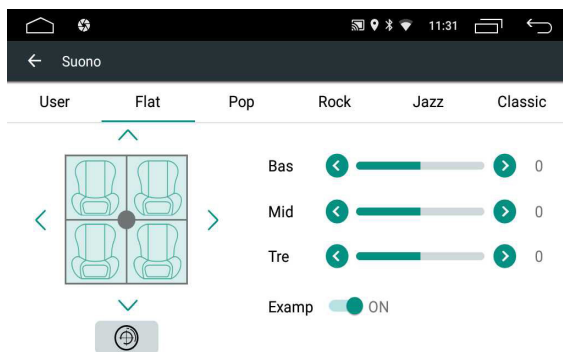

## IT

Premere l'icona  per modificare le impostazioni di fabbrica. Tramite le icone è possibile selezionare 6 diverse modalità di equalizzazione preimpostate: USER-FLAT-POP-ROCK-JAZZ-CLASSIC.

**EXAMP ON/OFF:** Attiva/Disattiva esaltazione basse frequenze.

Per regolare bilanciamento e il FADER utilizzare le frecce presenti sullo schermo .

## EN







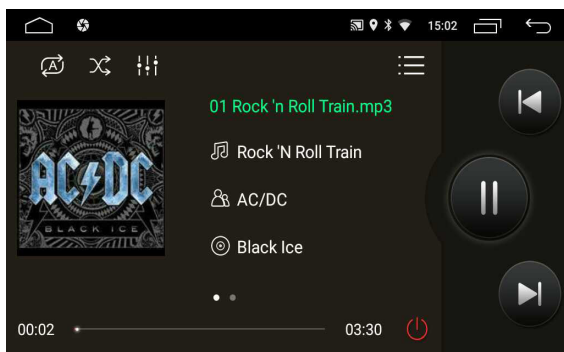



Press icon  to modify the factory settings. By means of the icons it is possible to choose 6 different predetermined equalization-modes: USER-FLAT-POP-ROCK-JAZZ-CLASSIC.

**EXAMP ON/OFF:** Activates/Deactivates Low Frequencies Booster

Use the arrows on the screen to adjust the balance and the FADER .











**IT**

**MUSICA:** Premendo sul touch screen l'icona  MUSICA del menù APP si accede alla funzione riproduzione musicale. Il sistema riconoscerà automaticamente i file inseriti in uno qualsiasi dei supporti (USB).

-  Torna al menu principale.
-  Visualizza le APP aperte in background
-  Passa alla schermata HOME
-  Ripete ciclicamente tutti i file presenti nella cartella.
-  Ripete il file in riproduzione.
-  Avvia riproduzione casuale dei file presenti nella cartella
-  Equalizzatore
-  Visualizza elenco file Audio disponibili
-  Traccia precedente o successiva
-  Avvia o mette in pausa la riproduzione
-  Interrompe la funzione RADIO e torna al menu principale

**EN**

**MUSIC:** By pressing the  icon on the touchscreen from the APP menu, it is possible to play music files. Select the file/folder, automatically recognized from the device, to Start playing

-  Back to previous menu
-  Shows the APPs open in background
-  Switches to HOME screen
-  Repeats cyclically all the files in the folder.
-  Repeats the file
-  Starts random playback of the files in the folder
-  Equalizer
-  File list
-  Track-Research forward/backward
-  Play/Pause
-  Stops the RADIO function and returns to the main menu

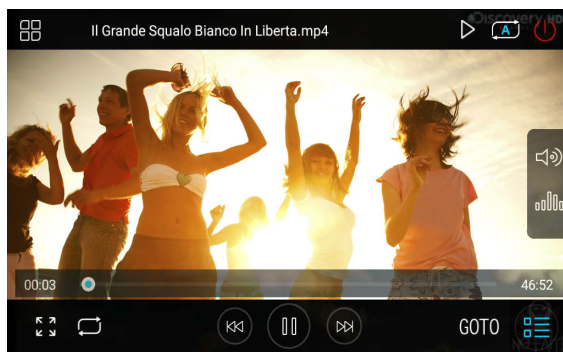
**IT**

**VIDEO:** Premendo sul touch screen l'icona ► VIDEO del menù APP si accede alla funzione riproduzione filmati. Il sistema riconosce automaticamente i file inseriti in uno qualsiasi dei supporti (USB).

- ⤵ Torna al menu principale.
- ☰ Visualizza le APP aperte in background
- 🏠 Passa alla schermata HOME
- ☰ Torna al menu principale
- ⏏ Visualizza schermo intero / 16:9 / 4:3 / centrato
- ☰ Visualizza elenco file Audio disponibili
- ▶▶|◀◀ Traccia precedente o successiva
- ▶|| Avvia o mette in pausa la riproduzione  
Permette di selezionare un punto desiderato del video tramite il minutaggio da tastierino numerico
- GOTO**
- 🔊 Apre la barra di selezione valore volume
- ⏏ Equalizzatore
- 🔌 Interrompe la funzione RADIO e torna al menu principale

**EN**

**VIDEO:** By pressing the ► icon on the APPS menu, it is possible to play video files. The system automatically recognizes the files entered in any of the media (USB).

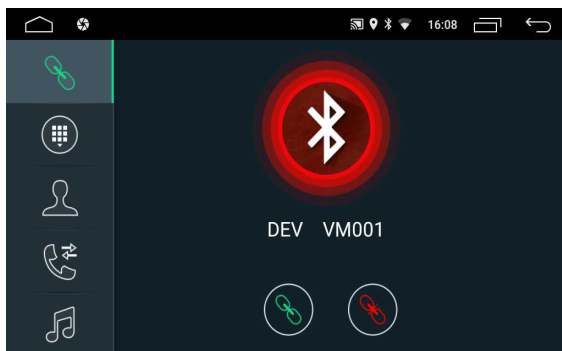

- ⤵ Back to previous menu
- ☰ Shows the APPs open in background
- 🏠 Switches to HOME screen
- ☰ Back to main menu
- ⏏ Displays full screen / 16:9 / 4:3 / centered
- ☰ Audio files list
- ▶▶|◀◀ Track-Research forward/backward
- ▶|| Play/Pause  
Allows you to select a desired point in the video by using the numeric keypad
- GOTO**
- 🔊 Opens the volume value selection bar
- ⏏ Equalizer
- 🔌 Stops the RADIO function and returns to the main menu



**IT**

**ACCOPPIAMENTO TELEFONO:** E' possibile accoppiare fino a 5 telefoni. Seleziona l'icona  dal menu principale per accedere alla funzione Bluetooth.



**RICERCA DAL TELEFONO:** Attivare la funzione Bluetooth sul telefono e ricercare nuovi dispositivi. Selezionare VM002 nella lista dispositivi. Ad accoppiamento avvenuto comparirà il nome del telefono. Attivare nelle impostazioni Bluetooth del telefono la connessione automatica del dispositivo.

**SINCRONIZZAZIONE RUBRICA:** Premere  dal menu Bluetooth per accedere alla sezione RUBRICA e selezionare l'icona  per scaricare il contenuto dal telefono al VM002. Automaticamente la rubrica del telefono verrà scaricata nella memoria dell'autoradio. Il tempo per l'operazione varia in base al numero dei contatti.

**EN**

**PHONE PAIRING:** Possibility of coupling up to 5 mobile-phones. Select the icon  for main menu for Bluetooth function.



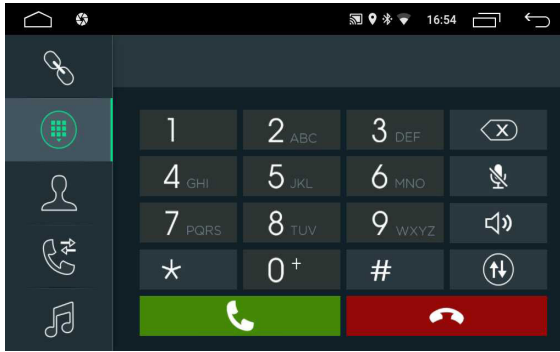

**RESEARCH THROUGH MOBILE-PHONE:** Select VM002 from the List of Devices. When pairing has taken place, phone-name will appear. Starting from the Bluetooth-Settings of the mobile- phone, activate the automatic connection.

**PHONE-BOOK SYNCHRONIZATION:** Press  on the Bluetooth menu to enter the PHONE-BOOK and select the icon  to download the phone-book content from the mobile-phone to VM002. The phone-book of your telephone will automatically be downloaded into the car-radio's memory. The time required for this operation depends on the number of contacts contained in the phone-book.







## IT

**EFFETTUARE UNA CHIAMATA:** Premere una delle icone presenti sullo schermo per chiamare da uno degli elenchi.





-  Chiamata da tastierino numerico
-  Selezione un contatto presente nella rubrica
-  Chiamate perse-ricevute-effettuate
-  Inviare la chiamata

**RICEVERE UNA CHIAMATA:** All'arrivo di una chiamata lo schermo passa in modalità Bluetooth visualizzando il numero del chiamante e il nominativo se memorizzato in rubrica.





-  Rispondere la chiamata
-  Rifiutare la chiamata.
-  Attiva / Disattiva microfono
-  Apre la barra di selezione valore volume
-  Mette in pausa / riprende una conversazione.

## EN

**MAKE A CALLING:** Press one of the icons on the screen to call from one of the lists.



-  Numeric keypad calling
-  Select a contact in the phonebook
-  LOST-RECEIVED-CALLED
-  To start a calling.

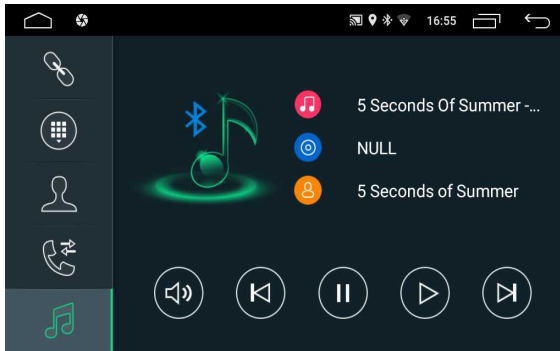

**ANSWERING A PHONE-CALL:** When phone-call arrives, screen switches to Bluetooth- mode and visualizes the caller's phone-number and name, if phone-list has previously been synchronized.

-  Press to answer
-  Press to reject the call.
-  Activates/Deactivates microphone
-  Opens the volume value selection bar
-  Pause / Continue a conversation







**IT**  
**RIPRODUZIONE MUSICA BLUETOOTH**

Se il telefono connesso supporta il profilo A2DP è possibile ascoltare i brani musicali sul VM002. Se il dispositivo supporta AVRCP sarà possibile controllare i brani musicali direttamente dal touch screen. Dal menu APP premere l'icona  BT MUSIC oppure l'icona  dal menu BLUETOOTH.

-  Traccia precedente o successiva
-  Avvia o mette in pausa la riproduzione
-  Apre la barra di selezione valore volume

**EN**  
**BLUETOOTH MUSIC PLAY**

If the connected phone supports the A2DP-Profile, you can listen to music. If the device supports AVRCP, the musical tracks can be handled on the touch-screen directly. Press  icon from APPs menu or  from BLUETOOTH menu.

-  Track-Research forward/backward
-  Play/Pause
-  Opens the volume value selection bar



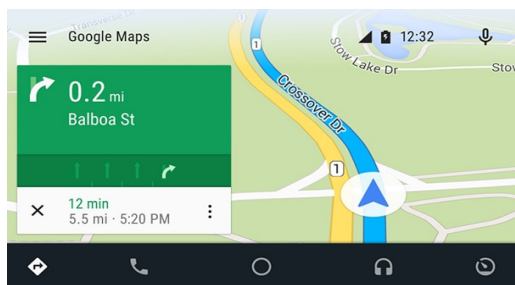

## IT - Il sistema multimediale è provvisto di **due soluzioni per la navigazione GPS.**

1) **Navigazione on-line:** è possibile utilizzare, grazie al sistema Android, l'applicazione MAPPE che permette di navigare tramite la cartografia di Google.

Per l'utilizzo di questa modalità il sistema deve essere connesso ad uno smartphone o tablet tramite Hotspot e la navigazione GPS sfrutterà la connessione dati con costi di utilizzo in base al proprio profilo tariffario. L'app ufficiale di Android offre navigazione GPS in tempo reale, informazioni su traffico, trasporto pubblico e dettagli su milioni di luoghi, come recensioni e orari di punta.

È possibile utilizzare mappe complete e precise di 220 paesi digitalizzate TOMTOM, con informazioni dettagliate su oltre 100 milioni di attività commerciali. Tutte le funzionalità sono disponibili con connessione dati 3G/4G, il sistema multimediale deve essere collegato ad uno smartphone/tablet in Hotspot.

2) **Navigazione off-line:** la nuova cartografia iGO Nextgen di Nav&Go con mappe TomTom è invece la soluzione professionale che completa il sistema multimediale rendendolo un accessorio indispensabile per l'attività giornaliera.

Se avete acquistato la versione con cartografia inclusa (VM002E Europa - VM002K Europa Truck) sarà possibile utilizzare tutte le funzionalità del nuovo software Nextgen: semplice ed essenziale, solo le funzioni che realmente servono alla guida.

Le mappe sempre disponibili per una navigazione sicura ed efficiente.

Metà dello spazio di memoria di altri sistemi di navigazione, permettendo di risparmiare memoria per le altre necessità nei viaggi, come musica e video. Opzioni di calcolo percorsi veloci e variegati per trovare sempre il miglior itinerario possibile. Disponibilità offline per essere sempre sulla strada giusta, in una affollatissima città come in una zona remota senza bisogno di connessione dati.

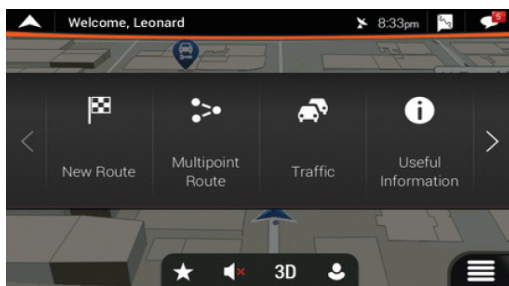

## **ATTENZIONE!!!**

Effettuando il "RESET DI FABBRICA" del VM002 tutti i file della navigazione iGO andranno persi. Prima di effettuare un "RESET DI FABBRICA" salvare tutti i dati della cartella IGO copiandoli su una Micro SD direttamente dall'applicazione "File Manager" presente di default.

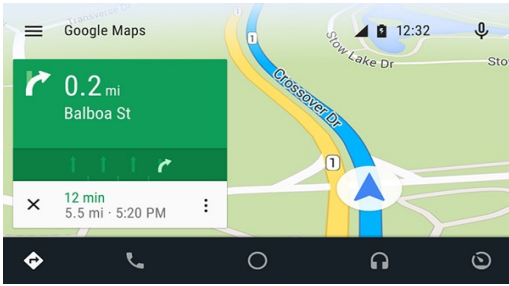

**EN -** The multimedia system is equipped with two GPS navigation solutions.

1) **Online navigation:** thanks to the Android system, you can use the MAPS application that allows you to navigate through Google cartography. In order to use this mode, the system must be connected to a smartphone or tablet via Hotspot . Thus, the GPS navigation will use the data connection, whose costs depend on your tariff profile. The official Android app provides real-time GPS navigation, traffic information, public transport and details about millions of locations, such as reviews and peak times.

Complete and precise TOMTOM digitalized maps of 220 countries can be used, with detailed information on over 100 million commercial activities. All the functionalities are available with 3G/4G data connection, the multimedia system must be connected to a smartphone/tablet in Hotspot.

2) **Off-line navigation:** the new Nav&Go Nextgen iGo mapping with TomTom maps is rather the professional solution, that completes the multimedia system making it an essential accessory for daily activity. If you have purchased the version with cartography included (VM002E Europa - VM002K Europa Truck), it will be possible to use all the functionalities of the new simple and essential Nextgen software: including only those functions that the driver needs. Maps are always available for a safe and efficient navigation. Half memory capacity of other navigation systems, which allows to save memory for other needs, when travelling, such as music and video. Fast and various route calculation options to always find the best possible route. Offline availability to be always on the right track, in a crowded city , as well as in a remote area without the need for a data connection.

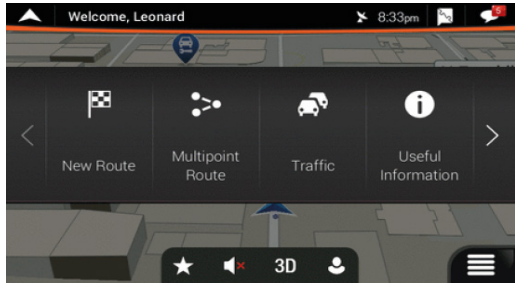

## WARNING!!!

*If you perform the "FACTORY RESET" of the VM002 all files from your iGO navigation will be lost. Before performing a "FACTORY RESET" save all the data of the IGO folder by copying them to a Micro SD directly from the "File Manager" application , present by default.*



**IT -** Premere icona **EASYCONNECTION** nel menù generale per accedere alle istruzioni di collegamento.  
**APPLE:** Attivare l’hotspot sul telefono/tablet e accoppiare il VM002. Avviare la duplicazione dello schermo e selezionare il dispositivo EC - MIRROR.

**ATTENZIONE:**

La riproduzione dei video su EASYCONNECTION con dispositivi iOS è limitata alle politiche di blocco APPLE. Questa APP permette di ricevere sul VM002 quello che viene visualizzato sullo schermo del dispositivo Apple. (YOUTUBE non permette la duplicazione dello schermo).

**ANDROID:** Selezionare sul telefono il Menù FUNZIONI SVILUPPATORE (seguire le istruzioni del proprio telefono). Attivare la funzione DEBUG USB e collegare il telefono all’ingresso USB ANTERIORE con un cavo USB che permetta la trasmissione dati. La funzione EASYCONNECTION si avvierà in automatico.

**ATTENZIONE:** il funzionamento della funzione con ANDROID è garantito con la versione ANDROID dal 6.0. Per la riproduzione dell’audio accoppiare il bluetooth del proprio smartphone con il VM002

**EN -** Press the **EASYCONNECTION** icon in the general menu to access the connection instructions.

**APPLE:** Activate the hotspot on the phone/tablet and connect the VM002. Start screen duplication and select the EC - MIRROR device.

**WARNING:**

Video playback on EASYCONNECTION with iOS devices is limited to APPLE lock policies.

With this APP you can receive on VM002 what is displayed on the screen of your Apple device. (YOUTUBE does not allow screen duplication).

**ANDROID:** Select the DEVELOPER FUNCTIONS menu on your phone (follow the instructions on your phone). Activate the USB DEBUG function and connect the phone to the USB FRONT input with a USB cable for data transfer. The EASYCONNECTION function will start automatically.

**WARNING:** The correct function with ANDROID is ensured with the ANDROID version 6.0 or higher. For audio playback, connect the Bluetooth of your smartphone to the VM002.

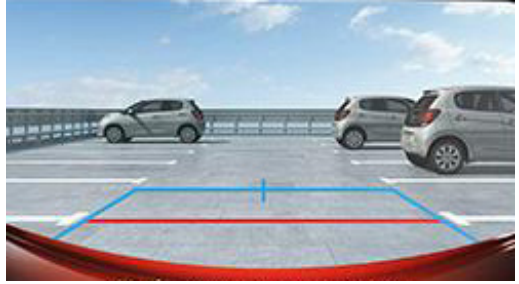

**IT - RETROCAMERA**

Collegare una retrocamera all’ingresso CAMERA e alle luci della retromarcia per l’alimentazione. Il VM002 visualizza automaticamente l’immagine all’ingresso della retromarcia. (Vedi collegamenti pag. 4).

**GB - REAR-CAMERA**

You can connect a rear-camera on CAMERA-input. The VM002 offers the possibility of automatically visualizing the rear-camera, if you connect the camera to the reverse-gear-lights (See connection-schemes page 4).

## Programmazione • Programming

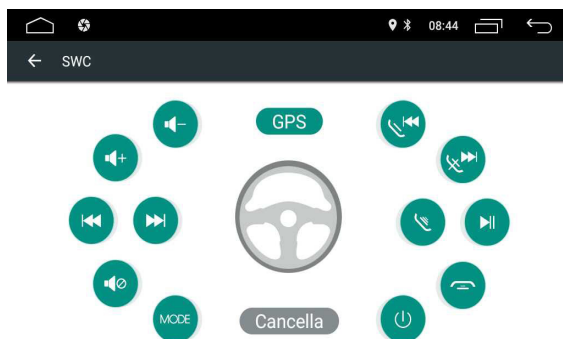

### IT

La programmazione è uguale sia per i comandi RESISTIVI, con o senza interfaccia, che con i CAN-BUS.

Premere l'icona  nel menu settaggi, dove verranno visualizzate le funzioni che si vogliono gestire dai comandi al volante della vettura.

Premere una delle funzioni per iniziare il settaggio (ES.  VOL+) l'icona inizierà a lampeggiare, e successivamente premere il comando sul volante che si desidera abbinare.

Effettuare questa operazione per tutti i comandi presenti sul volante, e uscire dal menu di memorizzazione comandi al volante. Per resettare le funzioni memorizzate e ricominciare l'abbinamento premere l'icona .

### EN

Programming-procedure is always the same, no matter if RESISTIVE commands (with or without Interface) or CAN-BUS.

Press  in the settings menu, where you will see the functions you want to manage from the steering wheel controls of the car.

Press one of the functions to start the setting (ES.  VOL+) the icon will start flashing, and then press the control on the steering wheel you want to pair.

Perform this operation for all the controls on the steering wheel and exit the SWC memorization menu. To reset the saved functions and start pairing again, press the icon .

Notice de montage et d'emploi • Gebrauchsanweisungen

# VM002

## Caracteristiques techniques • Technische daten

---

### FR

- Écran 6.95" digital TFT/LCD wide - Touch Screen
- Résolution 1024x600 pixel
- Reproduction vidéo 1080p
- SO Android 9.0
- Bluetooth mains libres avec microphone externe et A2DP
- Processeur 4 core 1.2 GHZ RAM 2 GB
- Memoire NAND 16 GB
- Radio RDS-EON PLL avec 18FM/12AM

### DE

- Digital TFT/LCD monitor 6.95" wide - Touch Screen
- Resolution 1024x600 pixel
- 1080P multimedia playback
- OS Android 9.0
- Bluetooth-Freisprecheinrichtung mit externem Mikrofon und A2DP-Funktion
- Prozessor 4 core 1.2 GHZ RAM 2 GB
- NAND Flash memory 16 GB
- Radiotuner RDS-EON PLL TUNER mit 18FM/12AM Presets

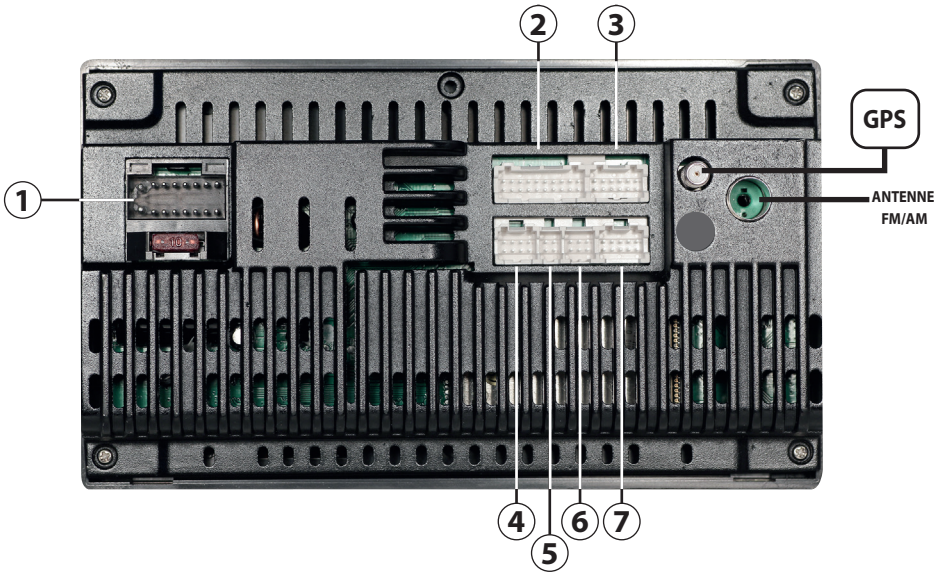

**1 ALIMENTATION - SORTIE HAUTPARLEUR / STROM-ZUFUHR - LAUTSPRECHER AUSGABE - SWC\***

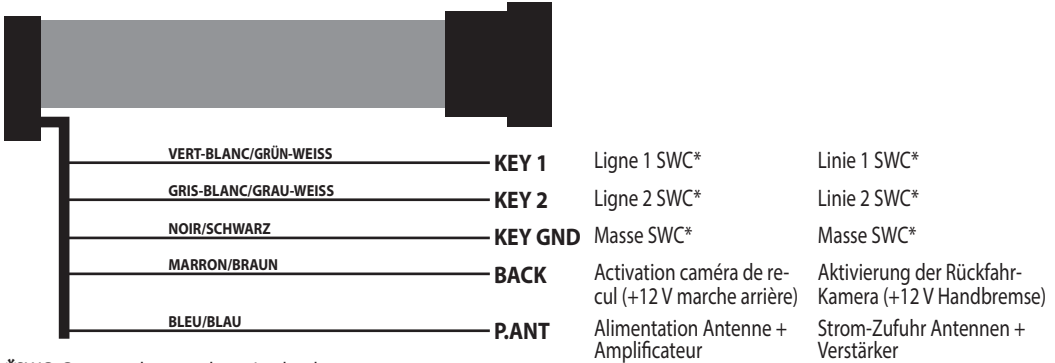

\*SWC: Commandes au volant • Lenkradsteuerungen

**2 SORTIES PRE-AMPLIFIEES PRE-AMP-AUSGÄNGE**

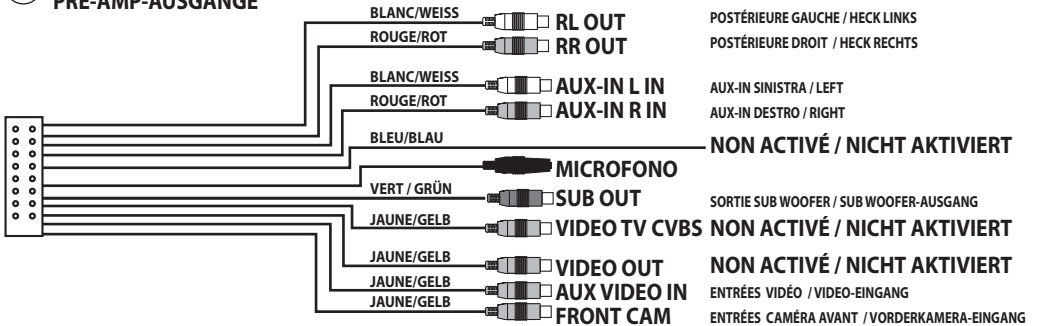

③ - ④ NON ACTIVÉ / NICHT AKTIVIERT

⑤ ENTRÉ USB / USB-ANSCHLUSS



⑥ NON ACTIVÉ / NICHT AKTIVIERT

⑦ FREIN DE STATIONNEMENT - CAMÉRA DE REcul/ HANDBREMSE - RÜCKFAHR-KAMERA

	VERT-BLANC/GRÜN-WEISS	<b>BRAKE</b>	Frein de stationnement (branchement obligatoire)	Handbremse (Anschluss unbedingt erforderlich)
	BLANC/WEISS	<b>NON ACTIVÉ / NICHT AKTIVIERT</b>		
	GRIS/GRAU	<b>NON ACTIVÉ / NICHT AKTIVIERT</b>		
	GRIS/GRAU	<b>CAM VIDEO IN</b>	Activation caméra de recul	Aktivierung der Rückfahr-Kamera

# Connexions commandes au volant Lenkradsteuerungen-Verbindungen

**FR** - Pour les branchements sur le connecteur original de la voiture, se servir du schéma de la notice de l'interface 04083.

Pour les voitures équipées de la ligne CAN, il faut brancher l'interface commandes au volant CAN-BUS.

**DE** - Bitte beachten Sie beim Anschluss an den Original-Konnektor das Anschlussschema in der Bedienungsanleitung der Interface 04083.

Für Autos, die über CAN-BUS verfügen, ist es notwendig, die CAN-BUS Lenkradsteuerungen anzuschließen.

CÂBLES / KABEL VM002		CÂBLES / KABEL 04083
KEY 1	>	VERT-BLANC/GRÜN-WEISS
KEY 2	>	GRIS-BLANC/GRAU-WEISS
KEY GND	>	NOIR/SCHWARZ

## CORRESPONDENCE COULEUR DES FILS KOMBINATION VON KABELFARBEN

### ESEMPLA / BEISPIEL

SCHEMA DE BRANCHEMENTS DANS LA NOTICE DU 04083  
ANSCHLUSSPLAN IN DER BEDIENUNGSANLEITUNG 04083

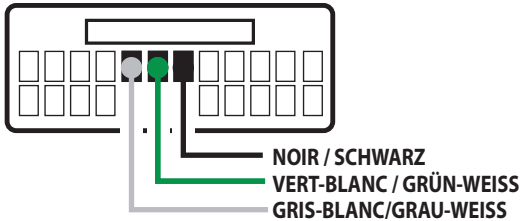

PROGRAMMATION AUTORADIO Voir pag. 37

SCHEMA DE BRANCHEMENTS DU VM002  
ANSCHLUSSPLAN VOM VM002

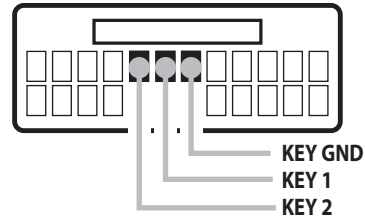

PROGRAMMIERUNG DES AUTORADIOS S.37



**FR**











1. Microphone Bluetooth Interne
2. Touche RESET
3. Touche MUTE (pression brève) – Allumage Extinction (pression pour 3 secondes)
4. Menu principal
5. Fonction précédente
6. Navigation
7. Volume + / Volume -

**DE**

1. Eingebautes Bluetooth Mikrofon
2. RESET-Taste
3. MUTE-Taste (kurzes Drücken) – Einschaltung-Ausschaltung ( 3 Sekunden Drücken)
4. Haupt-Menü
5. Zurück zur vorherigen Funktion
6. Navigation
7. Lautstärke + / Lautstärke -











**FR**

À l'allumage le VM002 lance le menu principal. Vous pouvez personnaliser ce menu avec les icônes des applications installées.

-  Revient au menu principal
-  Réglage Volume -
-  Réglage Volume +
-  Allumage/extinction éclairage LCD
-  Egaliseur
-  Position GPS reconnue
-  WI-FI activé et connecté
-  Bluetooth activé
-  Visualise toutes les APP ouvertes
-  Revient à la fonction précédente

**DE**

Beim Einschalten des VM002 wird das Hauptmenü automatisch gestartet. Sie können dieses Menü mit den Symbolen der installierten APPs anpassen.

-  Zurück zum Hauptmenü
-  Lautstärke -
-  Lautstärke +
-  Ein-Auswahlung der LCD Beleuchtung
-  Equalizer
-  Echte GPS-Position erkannt
-  WI-FI gepaart mit Signalstärke
-  Bluetooth ON
-  Offene APPs anzeigen
-  Zurück zur vorherigen Funktion

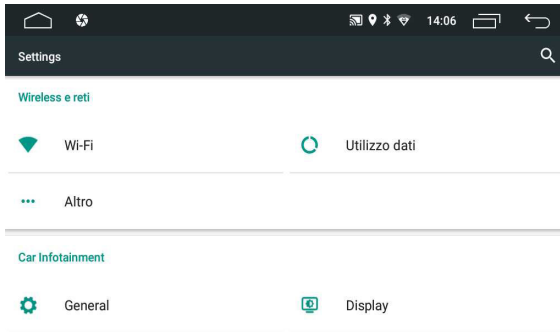

## FR

Appuyer sur l'icône  "SETTING" dans le menu principal, pour accéder aux réglages du système Android.

- **WIRELESS ET RESEAUX** : Active/désactive le WI-FI et permet le paramétrage avec un routeur accessible. Modifie les paramètres APN..
- **DIVERTISSEMENT EN VOITURE** : Permet de modifier les paramètres d'affichage, les paramètres généraux, les volumes et l'égaliseur. Change l'état du Bluetooth, accède à la mémorisation des commandes au volant, et affiche les informations logicielles.
- **DISPOSITIF**: Affiche l'espace de la mémoire interne et gère les APPS installées.
- **USER**: crée et affiche les paramètres du compte et sélectionne la langue du système d'exploitation.
- **SYSTÈME** : Réglage de l'heure et de la date. Affichage des informations matérielles et logicielles du système Android.





## DE





Drücken Sie das  Symbol im Hauptmenü, um auf die Android System-Einstellungen zuzugreifen.

- **WI-FI**: Schalten Sie die drahtlose Verbindung ein/aus und stellen Sie den Routerzugriff und die APN-Einstellung ein.
- **CAR INFOTAINMENT**: Regelung der Bildschirm- und allgemeinen Einstellungen. Regelung der Lautstärkewerten und des Equalizers. Änderung des Bluetooth-Status, Zugriff auf die Speicherung-Funktion der Lenkradsteuerungen. Anzeige der Softwareinformationen.
- **GERÄT**: Interner Speicherstatus und APP-Verwaltung
- **PERSÖNLICH**: Kontozugriff und Sprach-Einstellungen
- **SYSTEM**: Datum & Zeiteinstellung und Androidhardware und Softwareinformationen.

**FR**





Appuyez sur l'icône  du menu APP sur l'écran tactile pour accéder à la fonction de lecture RADIO.





-  Revient au menu principal.
-  Visualise les APP ouvertes
-  Passe à l'écran HOME
-  Ouvre le menu des réglages de la fonction RDS

- REGION** REGION: ON/OFF
- PI** PI: SOUND/MUTE
- TA** Active/Désactive les informations sur la circulation
- RETUNE** Short/Long
- AF** Active/Désactive la fréquence alternative RDS
- FM/AM** Bande radio
-  Recherche automatique et manuelle stations revient/avance
-  Balayage stations
-  Egaliseur
-  Arrête la fonction RADIO et revient au menu principal
-  Ouvrir pour le réglage du volume

**DE**

Drücken Sie  das APP-Menü-Symbol auf dem Touchscreen, um die RADIO-Wiedergabefunktion aufzurufen.

-  Zurück zum Hauptmenü
-  Zeigt Hintergrund-APPs an
-  HOME-Bildschirm
-  Öffnet das Menü RDS-Funktionseinstellungen.

- REGION** ON/OFF
- PI** SOUND/MUTE
- TA** EIN/AUS Verkehrsinformationskanal
- RETUNE** Kurz/Lang
- AF** EIN/AUS alternative Frequenz RDS
- FM/AM** Radiofrequenz AM/FM wechselnd
-  Autom./ Manuelle Sender-Suche rückwärts.
-  Sender scannen.
-  Equalizer
-  RADIO-Funktion wird unterbrochen. Zurück zum Hauptmenü
-  Stellt den Lautstärkewert ein

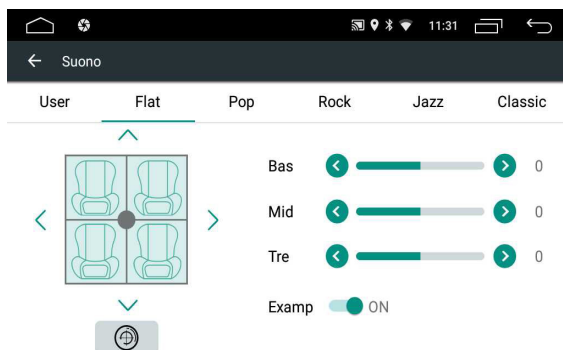
**FR**

Appuyer l'icône  pour modifier les réglages d'origine. A travers les icônes, on peut sélectionner 6 modalités différentes d'équilibre pré-réglées:

USER-FLAT-POP-ROCK-JAZZ-CLASSIC.

**EXAMP ON/OFF:** Active/Désactive l'exaltation des basses fréquences

Utiliser les flèches que vous trouvez sur l'écran pour les réglages du FADER et de l'ÉQUILIBRAGE .

**DE**

Drücken  Sie das Symbol um die Werkseinstellungen zu ändern. Über die Ikonen können 6 verschiedene, vorgegebene

Equalizer-Modi gewählt werden:

USER-FLATPOP- ROCK- JAZZ - CLASSIC





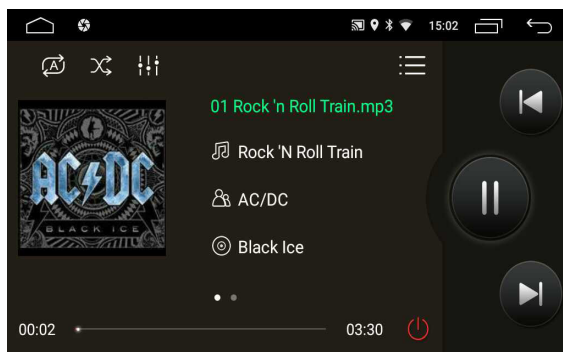





**EXAMP ON/OFF:** Aktiviert/Deaktiviert die Niederfrequenz Booster.

Verwenden Sie die Pfeile auf dem Bildschirm, um FADER und BALANCE einzustellen .















**FR**

**MUSIQUE:** Si vous appuyez sur l'icône  MUSIQUE dans le menu APP, il est possible de reproduire les fichiers musicaux. Sélectionnez le fichier/dossier, reconnu automatiquement à partir de l'appareil, pour commencer la lecture (USB).

-  Revient au menu principal
-  Visualise les APP ouvertes
-  Passe à l'écran HOME
-  Répétition en séquence des fichiers du dossier
-  Répétition du fichier en reproduction
-  Lance la reproduction aléatoire des fichiers du dossier
-  Egaliseur
-  Liste des fichiers audio disponibles
-  Trace suivante/précédente
-  Lance ou met en pause la reproduction
-  Arrête la fonction RADIO et revient au menu principal

**DE**

**MUSIK:** Wenn Sie das MUSIK-Symbol  im APP-Menü drücken, ist es möglich, Musikdateien abzuspielen. Wählen Sie die Datei/Ordner (auf USB-Stick), die vom Gerät automatisch erkannt werden, um die Wiedergabe zu starten.

-  Zurück zum Hauptmenü
-  Zeigt Hintergrund-APPs an
-  HOME-Bildschirm
-  Wiederholt nacheinander alle Dateien im Ordner.
-  Wiederholt die laufende Datei.
-  Startet die zufällige Wiedergabe von Dateien im Ordner.
-  Equalizer
-  Audio Detailliste
-  Track-Suche vorwärts/rückwärts
-  Wiedergabe/Pause
-  Stoppt die RADIO-Funktion und kehrt zum Hauptmenü zurück.

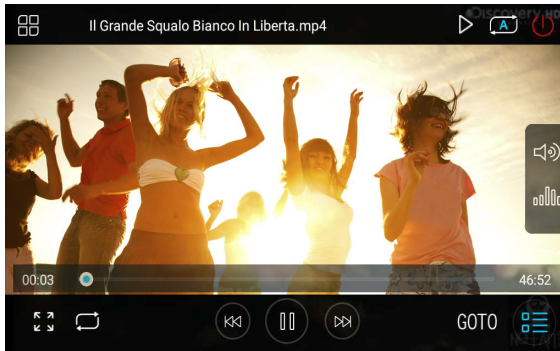

**FR**

**VIDEO:** Si vous appuyez sur l'icône ► dans le menu APP, il est possible de reproduire les fichiers vidéo. Le système reconnaît automatiquement les fichiers introduits dans n'importe quel support (USB).

- ↶ Revient au menu précédent
- ☰ Visualise les APP ouvertes
- 🏠 Passe à l'écran HOME
- ☰ Revient au menu principal
- ↕ Affichage plein écran / 16:9 / 4:3 / centré
- ☰ Liste des fichiers audio
- ▶▶|◀◀ Trace suivante/précédente
- ▶|| Lance ou met en pause la re production
- GOTO GOTO Permet de sélectionner un point de la vidéo à l'aide du clavier numérique.
- 🔊 Ouvrir pour le réglage du volume
- ⚖ Egaliseur
- 🔌 Arrête la fonction RADIO et revient au menu principal

**DE**

**VIDEO:** Wenn Sie das VIDEO-Symbol ► im APPs-Menü drücken. Wählen Sie die Datei/Ordner (auf USB-Stick/ SD Karte) , die vom Gerät automatisch erkannt werden ,um die Wiedergabe zu starten.

- ↶ Zurück zum vorherigen Menü
- ☰ Zeigt Hintergrund-APPs an
- 🏠 HOME-Bildschirm
- ☰ Zurück zum Hauptmenü
- ↕ Anzeige im Vollbildmodus / 16:9 / 4:3 / zentriert
- ☰ Audio Detailliste
- ▶▶|◀◀ Track-Suche vorwärts/rückwärts
- ▶|| Wiedergabe/Pause
- GOTO GOTO Von einem gewünschten Punkt ausgehend, Wiedergabe startet
- 🔊 Stellt den Lautstärkewert ein
- ⚖ Equalizer
- 🔌 Stoppt die RADIO-Funktion und kehrt zum Hauptmenü zurück.

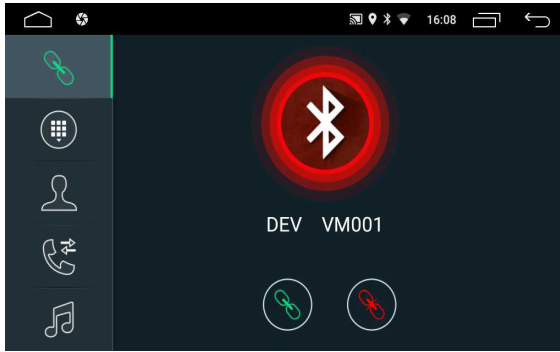

**FR**  
**PARAMETRAGE TELEPHONE**



Il est possible paramétrer jusqu'à 5 téléphones. Sélectionner  dans le menu principal pour accéder à la fonction Bluetooth

**RECHERCHE À PARTIR DU TÉLÉPHONE**

Activer la fonction bluetooth sur le téléphone et rechercher les nouveaux dispositifs. Chercher VM002 dans la liste des dispositifs.

Une fois que le paramétrage est fait, le nom du téléphone apparaît. Activer dans les réglages Bluetooth du téléphone la connexion automatique du dispositif

**SYNCHRONISATION DU REPERTOIRE**

Appuyer  dans le menu Bluetooth pour accéder au REPERTOIRE et sélectionner l'icone  pour télécharger le contenu à partir du téléphone sur le VM002.

Le répertoire du téléphone sera automatiquement téléchargé dans la mémoire de l'autoradio.

Le temps de l'opération varie en fonction du nombre des contacts.



**DE**  
**TELEFONVERBINDUNG**

Es ist möglich, bis zu 5 Mobiltelefone zu verbinden. Wählen Sie  aus dem Hauptmenü für die Bluetooth-Funktion.

**SUCHE AUS DEM HANDY**

Aus den Bluetooth-Einstellungen des Mobiltelefons, aktivieren Sie die automatische Verbindung. Wählen Sie VM002 aus der Geräteliste. Wenn die Verbindung hergestellt wurde, wird der Telefon-Name angezeigt. Aus den Bluetooth-Einstellungen des Mobiltelefons, aktivieren Sie die automatische Verbindung.

**TELEFONBUCH-SYNCHRONISATION**

Drücken Sie  aus dem Bluetooth-Menü, um das TELEFONBUCH aufzurufen und wählen Sie  um das Telefonbuch herunterzuladen.



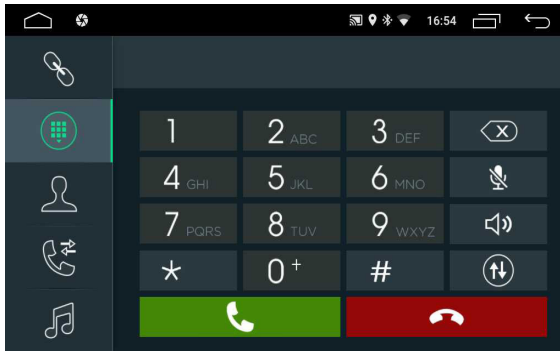

Das Telefonbuch Ihres Telefons wird automatisch in den Speicher des Autoradios geladen. Die für diesen Vorgang benötigte Zeit hängt von der Anzahl der im Telefonbuch enthaltenen Kontakte ab.









## FR EFFECTUER UN APPEL

Appuyer une des icônes présentes sur l'écran pour appeler à partir d'une des listes:

-  Appel à partir du clavier numérique.
-  Répertoire téléphonique (il doit être synchronisé)
-  Appels perdus-Appels reçus-Appels émis
-  Appuyer pour lancer l'appel.





## RECEVOIR UN APPEL

A l'entrée d'un appel, l'écran va en modalité Bluetooth en visualisant le numéro de celui qui appelle, et le nom si le répertoire est synchronisé.

-  Appuyer pour répondre
-  Appuyer pour refuser l'appel.
-  Active / Désactive le microphone
-  Ouvrir pour le réglage du volume
-  Pause / reprise d'une conversation.





## DE ANRUFEN

Drücken Sie eines der Symbole auf dem Bildschirm, um aus einer der Listen anzurufen.

-  Anrufen über die Tastatur
-  Einen Kontakt im Adressbuch auswählen
-  VERLOREN-EMPFANGEN-ANGERUFEN
-  Drücken Sie , um den Anruf zu senden.

## ANRUFANNAHME

Wenn ein Anruf eintrifft, wechselt der Bildschirm in den Bluetooth-Modus und zeigt die Telefonnummer und den Namen des Anrufers an, wenn die Telefonliste zuvor synchronisiert wurde.

-  Drücken um den Anruf anzunehmen
-  Drücken um abzulehnen.
-  Aktiviert / Deaktiviert das Mikrofon
-  Stellt die Lautstärke ein
-  Stoppt/ Setzt ein Gespräch fort

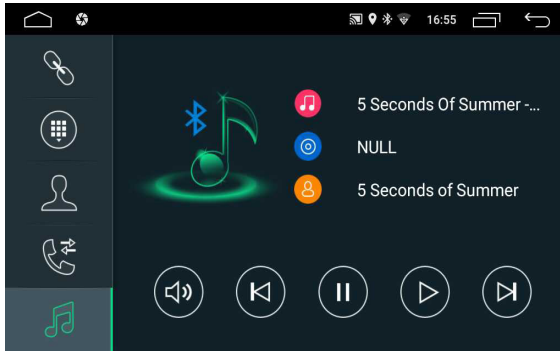

**FR**  
**REPRODUCTION MUSIQUE BLUETOOTH**

Si le téléphone branché supporte le profil AD2P, c'est possible d'écouter les chansons sur le VM002.  
Si le dispositif supporte AVRCP, les chansons pourront être contrôlées directement à partir de l'écran tactile. À partir du menu APP appuyer sur l'icône BT MUSIC ou sur l'icône du menu BLUETOOTH.

- Chanson précédente / suivante.
- Lance / interrompe la reproduction
- Ouvrir pour le réglage du volume

**DE**  
**BLUETOOTH MUSIK WIEDERGABE:**

Wenn das angeschlossene Telefon das A2DP-Profil unterstützt, können Sie Musik auf VM002 hören. Wenn das Gerät AVRCP unterstützt, können die Musiktitel direkt auf dem Touchscreen bedient werden. Drücken Sie im APP-Menü das Symbol oder das Symbol aus dem Bluetooth- Menü

- Vorheriger/nächster Track.
- Starten oder Stoppen der Wiedergabe
- Stellt die Lautstärke ein

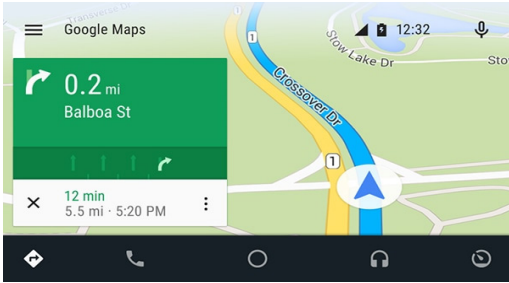

## FR - Le système multimédia a deux solutions pour la navigation GPS.

1) **Navigation en ligne:** grâce au système Android, vous pouvez utiliser l'application MAPPE qui permet de naviguer moyennant la cartographie de Google. Pour utiliser cette modalité, le système doit être connecté à un smartphone ou à une tablette via Hotspot et la navigation GPS utilisera la connexion de données et les coûts seront ceux de votre profil tarifaire.

L'application officielle Android fournit la navigation GPS en temps réel, les infos trafic, le transport public et des détails sur des millions d'endroits, tels que les commentaires et les heures de pointe.

Des cartes numériques TOMTOM complètes et précises de 220 pays peuvent être utilisées, avec des informations détaillées sur plus de 100 millions d'activités commerciales.

Toutes les fonctionnalités sont disponibles avec la connexion de données 3G/4G, le système multimédia doit être connecté à un smartphone / tablette en Hotspot.

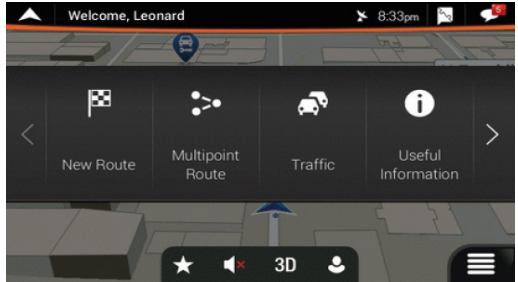

2) **Navigation Hors-ligne (OFF-LINE)** : la nouvelle cartographie Nav&Go Nextgen iGo avec cartes TomTom est la solution plus professionnelle, qui complète le système multimédia et en fait un accessoire indispensable pour les activités quotidiennes. Si vous avez acheté la version avec cartographie incluse (VM002E), vous pourrez utiliser toutes les fonctionnalités du nouveau logiciel Nextgen: simple et essentiel, équipé uniquement des fonctions dont le conducteur a réellement besoin. Les cartes sont toujours disponibles pour une navigation sûre et efficace. Disponibilité de la moitié de l'espace de mémoire par rapport aux autres systèmes de navigation, ce qui permet d'avoir de la mémoire disponible pour d'autres nécessités, comme la musique et la vidéo, lors des déplacements.

Calculs rapides et variées des itinéraires pour trouver le meilleur chemin possible. La possibilité off-ligne vous permet d'être toujours sur la bonne route, soit dans une ville habitée que dans une zone isolée sans besoin de connexion de données.

**AVERTISSEMENT!!!**  
*Si vous effectuez la réinitialisation des paramètres d'usine (FACTORY RESET) du VM002, tous les fichiers de votre navigation iGO seront perdus. Avant d'effectuer une réinitialisation, sauvegardez toutes les données du dossier IGO en les copiant dans une Micro SD, à partir de l'application «File Manager» présente par défaut.*

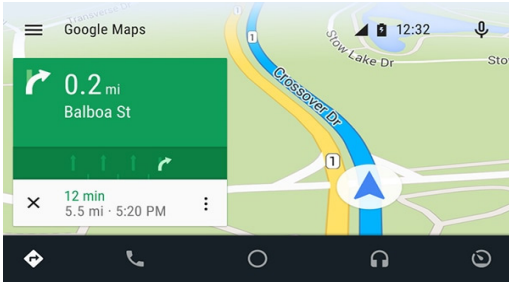

**DE -** Das Multimediasystem verfügt über **zwei GPS-Navigationsmöglichkeiten.**

1) **Online-Navigation:** Dank des Android-Systems können Sie die MAPS-Anwendung nutzen, mit der Sie durch die Google-APP navigieren können.

Um diesen Modus nutzen zu können, muss das System über Hotspot mit einem Smartphone oder Tablet verbunden sein. So nutzt die GPS-Navigation die Datenverbindung, deren Kosten von Ihrem Tarifprofil abhängen. Die offizielle Android-App bietet Echtzeit-GPS-Navigation, Verkehrsinformationen, öffentliche Verkehrsmittel und Details zu Millionen von Orten, wie z.B. Bewertungen und Verkehrsdichte.

Es können komplette und präzise digitalisierte TOMTOM-Karten von 220 Ländern verwendet werden, mit detaillierten Informationen bis zu über 100 Millionen geschäftlichen Aktivitäten.

Alle Funktionalitäten sind bei 3G/4G Datenverbindung verfügbar, das Multimediasystem muss mit einem Smartphone/Tablet über Hotspot verbunden werden.

2) **Offline-Navigation:** Das neue Nav&Go Nextgen

iGo Mapping mit TomTom-Karten ist eher eine professionelle Lösung, die das Multimediasystem vervollständigt und es zu einem unverzichtbaren Zubehör für die tägliche Arbeit macht.

Wenn Sie die Version mit Navi-Software erworben haben, können Sie alle Funktionalitäten der neuen einfachen und intuitiven Nextgen-Software nutzen, die nur die Funktionen umfasst, die der Fahrer wirklich benötigt.

Für eine sichere und effiziente Navigation stehen die Karten jederzeit zur Verfügung.

Halbe Speicherkapazität im Vergleich zu anderen Navigationssystemen, die es ermöglicht, Speicherplatz für andere Bedürfnisse auf dem Weg zu sparen, wie z.B. Musik und Video.

Schnelle und vielfältige Routenberechnungsoptionen, um immer die bestmögliche Route zu finden. Offline-Verfügbarkeit, um immer auf dem richtigen Weg zu sein, sowohl in einer Großstadt, als auch in einem abgelegenen Gebiet ohne Datenverbindung.

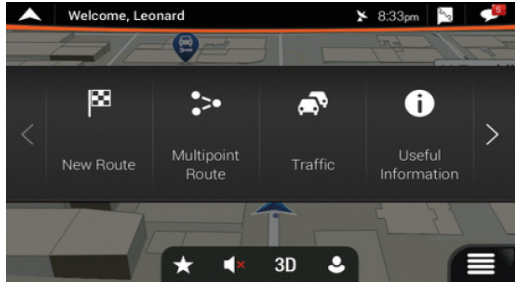

## VORSICHT!!!

*Wenn Sie eine Rückstellung der Werkseinstellungen des VM002 durchführen („FACTORY RESET“), gehen alle Dateien aus Ihrer iGO-Navigation verloren. Bevor Sie einen „FACTORY RESET“ durchführen, speichern Sie alle Daten des IGO-Ordners, indem Sie diese direkt aus der vorhandenen Anwendung „File Manager“ auf eine Micro SD kopieren.*



**FR** - Appuyer sur l'icône **EASYCONNECTION** dans le menu général pour accéder aux infos de connexion.

**APPLE** : activer le hotspot sur le téléphone / Tablette et paramétrer le VM002. Commencer le dédoublement de l'écran et choisir EC-MIRROR

#### **ATTENTION:**

La reproduction des vidéos sur EASYCONNECTION avec les dispositifs iOS est déterminée par la politique de blocage APPLE

Cette APP permet de recevoir sur le VM002 tous ce qui est visible sur l'écran du dispositif Apple (YOUTUBE ne permet pas le dédoublement de l'écran)

**ANDROID** : Sélectionner sur le téléphone le menu FONCTIONS DEVELOPPEUR (suivre les instructions de son téléphone personnel). Activer la fonction DEBUG USB et brancher le téléphone à l'entrée USB AVANT avec un câble de transmission des données. La fonction EASYCONNECTION s'ouvrira automatiquement.

**ATTENTION** : le fonctionnement de EASYCONNECTION avec ANDROID est garanti avec les versions ANDROID à partir de 6.0. pour la reproduction audio, paramétrer le Bluetooth de son smartphone au VM002.

**DE** - Drücken Sie das **EASYCONNECTION**-Symbol im allgemeinen Menü, um auf die Verbindungsanweisungen zuzugreifen.

**APPLE**: Aktivieren Sie den Hotspot auf dem Telefon/ Tablet und verbinden Sie das VM002. Starten Sie die Bildschirm-Duplizierung und wählen Sie das Gerät EC - MIRROR.

#### **WARNUNG:**

Die Videowiedergabe bei EASYCONNECTION mit iOS-Geräten ist auf APPLE-Sperrichtlinien beschränkt. Mit dieser APP können Sie auf VM002 empfangen, was auf dem Bildschirm Ihres Apple-Gerätes angezeigt wird. (YOUTUBE erlaubt keine Bildschirm-Duplizierung).

**ANDROID**: Wählen Sie das Menü ENTWICKLERFUNKTIONEN auf Ihrem Telefon (folgen Sie den Anweisungen Ihres Telefons). Aktivieren Sie die Funktion USB DEBUG und schließen Sie das Telefon zur Datenübertragung mit einem USB-Kabel an den USB FRONT-Eingang an. Die Funktion EASYCONNECTION wird automatisch gestartet.

**WARNING:** Die richtige Funktion mit ANDROID ist mit der ANDROID-Version ab 6.0 gewährleistet. Für die Audiowiedergabe schließen Sie das Bluetooth Ihres Smartphones an das VM002.



#### **FR - CAMERA DE REcul**

Brancher une caméra de recul à l'entrée CAMERA et aux lumière de marche arrière pour l'alimentation électrique. Le VM002 affiche automatiquement l'image lorsque la marche arrière est engagée. (Voir les connexions page 22).

#### **DE - RÜCKFAHRKAMERA**

Sie können eine Rückfahrkamera am Kamera-Eingang anschließen. Die VM002 bietet die Möglichkeit, die Rückfahrkamera automatisch zu visualisieren, wenn Sie die Kamera an die Rückfahrcheinwerfer anschließen (siehe Anschlussplan Seite 22); in diesem Fall werden die Rückfahrkamera-Bilder jedes Mal angezeigt, wenn Sie die Rückfahrkamera einlegen.

## Programmation • Programmierung

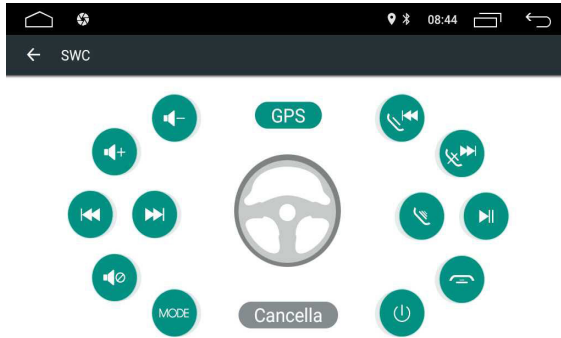



### FR

La programmation est la même soit en ce qui concerne les commandes au volant RESISTIVES, avec ou sans interface, que les commandes CAN-BUS.

Appuyer l'icône SWC  dans le menu des réglages, où seront visualisées les fonctions qu'on veut gérer à partir des commandes au volant de la voiture.

Appuyez sur l'une des fonctions pour effectuer le réglage. (ES. )

l'icône commence à clignoter. Ensuite appuyez sur la commande au volant que vous voulez associer.

Faire cette opération pour toutes les commandes présentes sur le volant et quitter le menu de mémorisation des commandes au volant. En cas d'erreur, appuyer l'icône  pour mettre à zéro l'apprentissage des commandes et recommencer la programmation .

### DE

Programming-procedure is always the same, no matter if RESISTIVE commands (with or without Interface) or CAN-BUS.

Press  in the settings menu, where you will see the functions you want to manage from the steering wheel controls of the car.

Press one of the functions to start the setting (ES. ) the icon will start flashing, and then press the control on the steering wheel you want to pair.

Perform this operation for all the controls on the steering wheel and exit the SWC memorization menu. To reset the saved functions and start pairing again, press the icon .

## MANUAL DE INSTRUCCIONES

# VM002

ES

### Características técnicas

---

#### ES

- Monitor 6,95" WVGA TFT LCD digital - Touch Screen
- Alto brillo y resolución 800x480 píxeles onocar
- Reproducción video 1080p
- Sistema operativo Android 9.0
- Manos libres bluetooth con micrófono exterior y función A2DP
- Microprocesador 4 core 1.2 GHZ RAM 2 GB
- Memoria interna NAND 16 GB
- Sintonizador radio RDS-EON PLL Emisoras memorizables 18FM/12AM

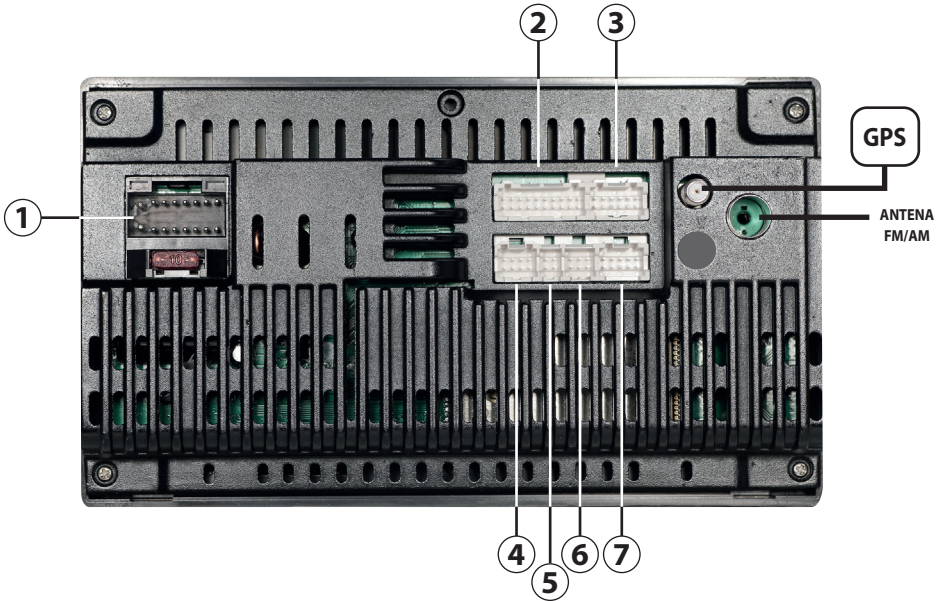

**1 ALIMENTACION - SALIDAS ALTAVOCES - SWC\***

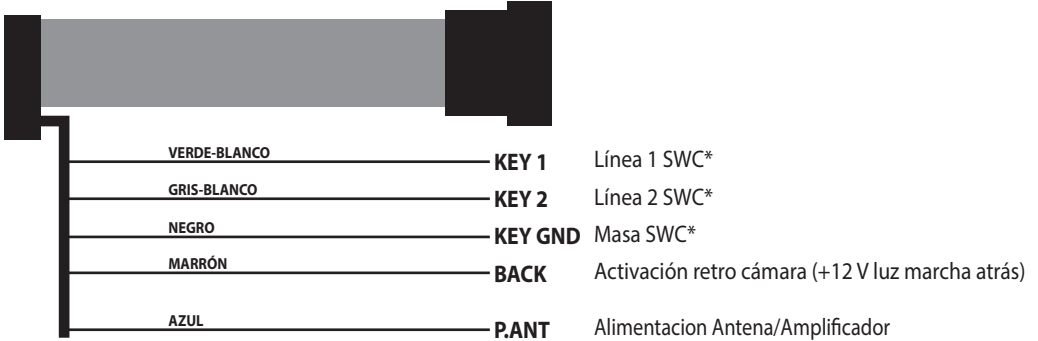

\*SWC: Mandos de Volante

**2 SALIDA PRE-AMP**

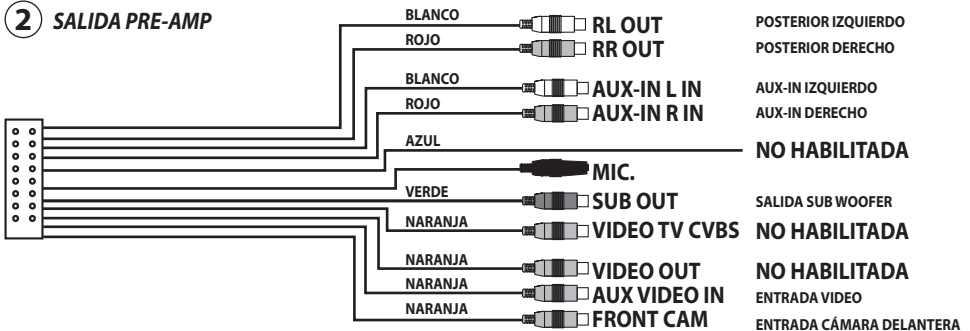



③ - ④ NO HABILITADO

⑤ USB PLUG-IN  USB

⑥ NO HABILITADO

⑦ FRENO DE MANO - SALIDA RETRO CÁMARA

••	VERDE-BLANCO	BRAKE	Freno de mano (conexión obligatoria)
••	BLANCO	NO HABILITADO	
••	GRIS	CAM VIDEO IN	Activación retro cámara (+12 V luz marcha atrás)
••	GRIS		

## Conexiones mandos de volante

**ES** - Para las conexiones al conector original del coche utilizar los esquemas presentes en el manual del usuario del interfaz 04083.

Para los coches con mandos de volante con linea CAN es necesario conectar el interfaz CAN-BUS.

CABLES VM002		CABLES 04083
KEY 1	>	VERDE-BLANCO
KEY 2	>	GRIS-BLANCO
KEY GND	>	NEGRO

### CORRESPONDENCIA COLOR CABLES

### EJEMPLO

DIAGRAMA DE CONEXIONES  
MANUAL DE INSTRUCCIONES 04083



DIAGRAMA DE CONEXIONES VM002



PROGRAMACIÓN AUTORADIO Ver pág. 53



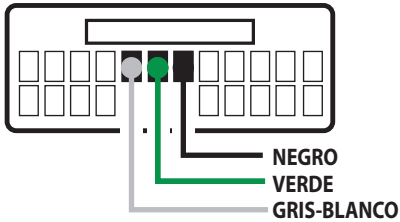
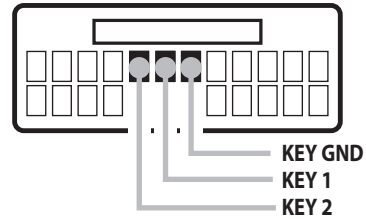











**ES**

1. Micrófono Bluetooth Interno
2. Tecla RESET
3. Tecla MUTE (presión breve) / Encendido/Apagado (presionar durante 3 segundos)
4. Menú principal
5. Vuelve a la función anterior
6. Navegación
7. Volumen + / Volumen -

**ES**

Cuando se enciende el VM002 inicia con el menú principal.

Puede personalizar este menú con los iconos de las aplicaciones instaladas.

-  Vuelve al menú principal.
-  Ajuste Volumen -
-  Ajuste Volumen +
-  Enciende /apaga la iluminación LCD
-  Ecualizador audio
-  Menú principal
-  Menú Aplicaciones
-  Posición GPS reconocida
-  WI-FI activado y conectado
-  Bluetooth encendido
-  Visualización de todas las aplicaciones abiertas
-  Vuelve a la función anterior

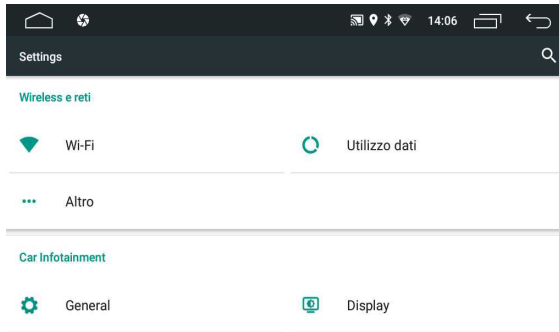





## ES





Pulsar el icono  "SETTING" del menú principal para acceder a los ajustes del sistema Android.

- **WIRELESS Y REDES:** Activa/desactiva el Wi-Fi y permite acoplarse con un router a su alcance. Modifica los ajustes del APN.
- **CAR INFOTAINMENT:** Permite modificar los ajustes del display, generales, configura los volúmenes y el ecualizador, modifica el estado del Bluetooth, accede a la memorización de los mandos de volante y visualiza las informaciones del software.
- **DISPOSITIVO:** Visualiza el espacio de la memoria interna y gestiona las APPS instaladas
- **PERSONALES:** Crea y visualiza los ajustes de la cuenta y selecciona el idioma del sistema
- **SISTEMA:** Ajustes del horario y fecha. Visualización de las informaciones del hardware y software del sistema Android.

**ES**

Pulsar en la pantalla táctil el icono  del menú APP se accede a la función reproducción RADIO.

-  Vuelve al menú principal.
-  Visualiza las APP abiertas en background
-  Pasa a la ventana HOME
-  Abre el menú de ajustes funciones RDS

- REGION** REGION: ON/OFF
- PI** PI: SOUND/MUTE
- TA** TA: Activa/Desactiva recepción informaciones de trafico
- RETUNE** RETUNE: Corta/Larga
- AF** AF: Activa/Desactiva frecuencia alternativa RDS
- FM/AM** FM/AM: Banda radio
-  Búsqueda automática y manual de emisoras Adelante/Atrás
-  Búsqueda aleatoria emisoras
-  Ecualizador
-  Interrumpe la función RADIO y vuelve al menú principal
-  Abre la barra de selección del volumen

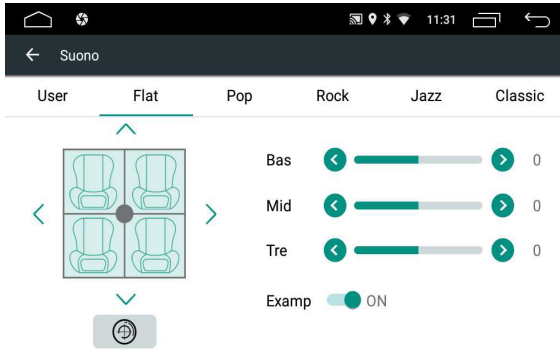

## ES

Pulsar el icono  para modificar los ajustes de fábrica. Mediante los iconos es posible seleccionar 6 diferentes modos de ecualización pre configurados:

PERSONALIZADO-STANDARD-POP-ROCK-CLASSIC-JAZZ





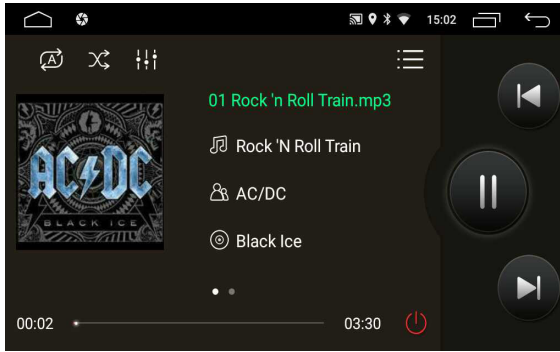





• **EXAMP ON/OFF:** Activa/ Desactiva exaltación de los graves.

Para ajustar el BALANCE Y EL FADER utilizar las flechas presentes en la pantalla .



**ES**

**MUSICA:** Pulsando en la pantalla el icono  MUSICA del menú APP se accede a la función reproducción musical. El sistema reconocerá automáticamente los archivos introducidos en cualquiera de los soportes (USB).

-  Vuelve al menú principal.
-  Visualiza las APPS abiertas en background
-  Vuelve a la pantalla HOME
-  Repite ciclicamente todos los archivos en reproducción.
-  Inicia la reproducción casual de los archivos presentes en la carpeta
-  Ecualizador
-  Visualiza lista archivos Audio disponibles. Pista precedente o siguiente
-  Inicia o pone en pausa la reproducción
-  Interrumpe la función RADIO y vuelve al menú principal
-  Avvia o mette in pausa la riproduzione
-  Interrompe la funzione RADIO e torna al menu principale



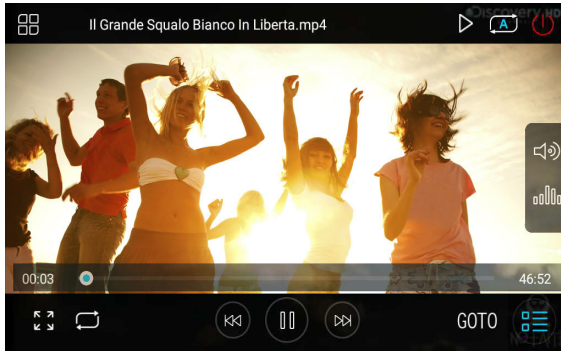



**ES**

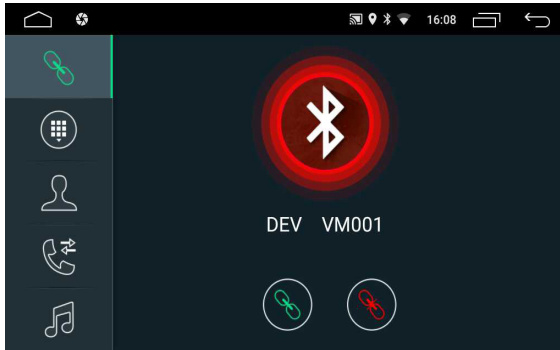

**VIDEO:** Pulsando en la pantalla el icono VIDEO del menú APP se accede a la función reproducción Video. El sistema reconocerá automáticamente los archivos introducidos en cualquiera de los soportes (USB).

- Vuelve al menú principal.
- Visualiza las APPS abiertas en background
- Vuelve a la pantalla HOME
- Vuelve al menú principal
- Visualiza pantalla entera / 16:9 / 4:3 / centrada
- Visualiza lista archivo de Audio disponibles
- Pista precedente o siguiente
- Inicia o mete en pausa la reproducción
- GOTO** GOTO Permite seleccionar un punto deseado del video mediante el teclado numérico
- Abre la barra de selección del volumen
- Ecualizador
- Interrumpe la función RADIO y vuelve al menú principal

**ES**

**EMPAREJAMIENTO TELEFONO:** Es posible acoplar hasta 5 teléfonos. Selecciona el icono  desde el menú principal para acceder a la función Bluetooth.

**BUSQUEDA DESDE EL TELEFONO:** Activar la función Bluetooth en el teléfono y buscar nuevos dispositivos. Seleccionar VM002 en la lista de los dispositivos. Una vez realizado el acoplamiento aparecerá el nombre del teléfono. Activar en los ajustes Bluetooth del teléfono, la conexión automática del dispositivo.



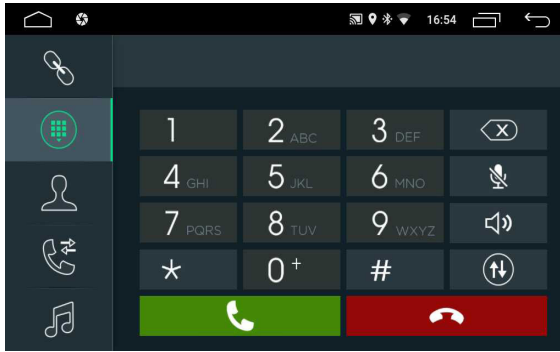

**SINCRONIZACION CONTACTOS:** Pulsar  en el menú Bluetooth para acceder a la sección Agenda y seleccionar el icono  para descargar el contenido desde el teléfono hasta el VM002. Automáticamente se descargarán en la memoria del autorradio los contactos del teléfono. El tiempo que se necesita para la operación dependerá de la cantidad de contactos que existan en el teléfono.









## ES

### EFECTUAR UNA LLAMADA

Pulsar uno de los iconos presentes en la pantalla para llamar desde unos de los elencos.

-  Llamada desde el teclado numérico
-  Selecciona un contacto presente en la lista de la Agenda
-  Llamadas perdidas-recibidas-efectuadas
-  Pulsar el icono para realizar una llamada.



**RECIBIR UNA LLAMADA:** A la llegada de una llamada la pantalla pasa en modo Bluetooth visualizando el número de quien llama y el nombre si ya se encuentra memorizado en la lista de contactos. Pulsar  para contestar o  para rechazar la llamada entrante.

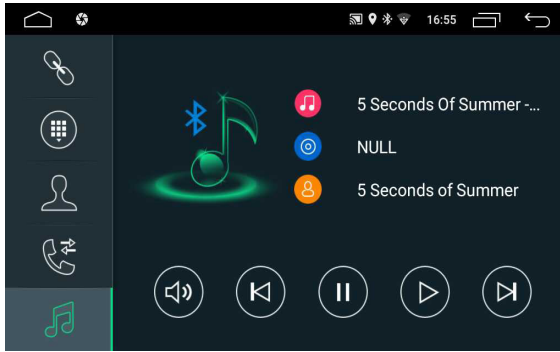

-  Pulsar para contestar
-  Pulsar para rechazar la llamada entrante.
-  Activa / Desactiva micrófono
-  Abre la barra de selección del volumen
-  Mete en pausa / reanuda la conversación.



## ES

### REPRODUCCION MUSICA BLUETOOTH

Si el teléfono conectado es compatible con la función A2DP es posible escuchar las canciones o pistas musicales en el VM002. Si el dispositivo es además compatible con la función AVRVP será posible controlar las pistas directamente desde la pantalla táctil del autorradio. En el menú principal APP pulsar el icono  BT MUSIC o bien el icono  del menú BLUETOOTH.

-  Pista precedente o siguiente
-  Inicia o mete en pausa la reproducción
-  Abre la barra de selección del volumen

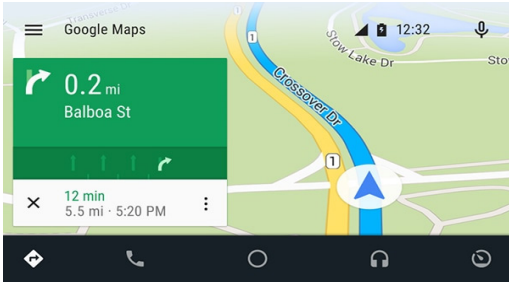

**ES - El sistema multimedia dispone de dos soluciones para la navegación GPS.**

1) **Navegación on-line:** es posible utilizar, gracias al sistema Android, la aplicación MAPAS que permite navegar mediante la cartografía de Google. Para utilizar este modo el sistema tiene que estar conectado a un Smartphone o Tablet mediante Hotspot y la navegación GPS aprovechará la conexión de datos con costes de utilización según la tarifa establecida con su compañía telefónica. La APP oficial de Android ofrece la navegación GPS en tiempo real, informaciones del tráfico, transporte público y detalles sobre millones de lugares, como reseñas y horarios de punta. Es posible utilizar mapas completos y precisos de 220 países digitalizados por TOMTOM, con informaciones detalladas de más de 100 millones de actividades comerciales. Todas las funcionalidades están disponibles con conexión de datos 3G/4G, el sistema multimedia debe estar conectado a un Smartphone /Tablet en Hotspot.

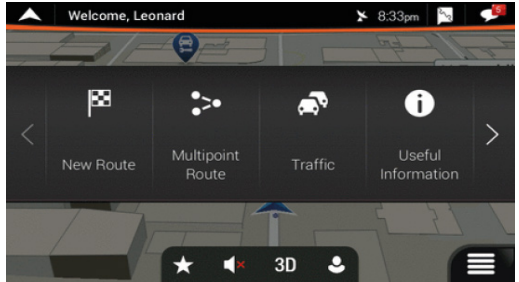

2) **Navegación off-line:** la nueva cartografía iGo Nextgen de Nav&Go con mapas TomTom es la solución profesional que completa el sistema multimedia rindiéndolo además un accesorio indispensable para las actividades cotidianas. Si habéis comprado la versión con cartografía incluida (VM002E) será posible utilizar todas las funcionalidades del nuevo software Nextgen: sencillo y esencial, solo las funciones que realmente sirven durante la conducción. Los mapas siempre disponibles para una navegación segura y eficiente. Mitad del espacio de memoria de otros sistemas de navegación, permitiendo ahorrar memoria para otras necesidades, en los viajes, como música e video. Opciones de recorridos rápidos y variedad para buscar siempre el mejor itinerario posible. Disponibilidad offline para estar siempre en el correcto recorrido, en una llenísima ciudad como en una zona remota sin necesidad de conexión por datos.

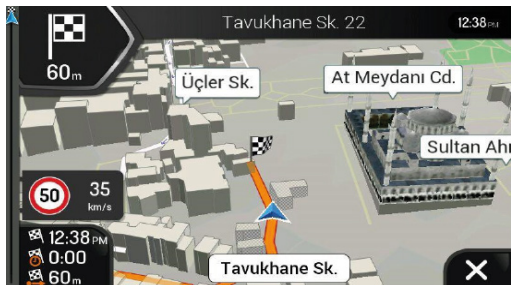

## PRECAUCIÓN!!!

*Efectuando el "RESET DI FABBRICA" del VM002 todos los archivos de navegación iGO se van a perder. Antes de efectuar un "RESET DE FABRICA" guardar todos los datos de la carpeta IGO en una Micro SD directamente desde la aplicación "File Manager" presente por default (por defecto).*

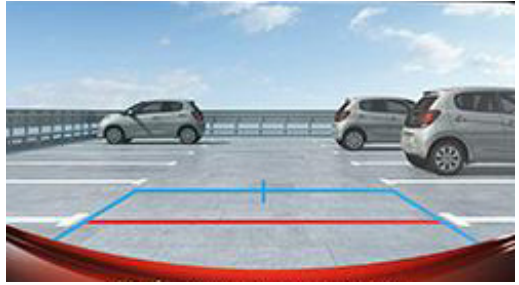

**ES** – Pulsar el ícono **EASYCONNECTION** en el menú general para acceder a las instrucciones de conexión.

**APPLE:** activar el hotspot (punto de acceso) en el teléfono / tableta y emparejar el VM002. Iniciar la duplicación de pantalla y seleccionar el dispositivo EC - MIRROR. **PRECAUCIÓN:**

La reproducción de videos con EASYCONNECTION con dispositivos iOS se limita a las políticas de bloqueo de APPLE.

Esta aplicación le permite visualizar en el VM002 lo que muestra la pantalla del dispositivo Apple.

(YOUTUBE no permite la duplicación de pantalla).

**ANDROID:** seleccionar en el menú del teléfono la FUNCIÓN DESARROLLADOR y seguir las instrucciones de su Smartphone. Activar la función USB DEBUG y conectar el teléfono a la entrada USB FRONTAL mediante cable USB que permita la transmisión de datos. La función EASYCONNECTION se iniciará automáticamente.

**ATENCIÓN:** el funcionamiento con ANDROID está garantizado a partir de la versión ANDROID 6.0. Para la reproducción de audio, emparejar el bluetooth de su Smartphone con el VM002

## ES - RETRO-CAMARA

Conectar una retro-cámara a la entrada CÁMARA del VM002 y al positivo de la bombilla de la marcha atrás. El VM002 visualizará automáticamente la imagen de la cámara después de insertar la marcha atrás. (Ver conexiones pág. 40).

## Programación

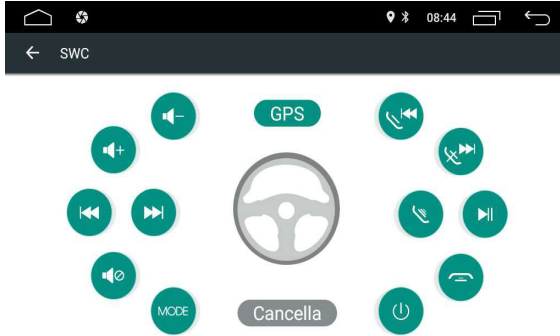

### ES

La programación es la misma para los sistemas RESISTIVOS, con o sin interfaz que con el sistema CAN-BUS. Pulsar el icono  en el menú de ajustes, donde se visualizaran las funciones que se desean gestionar mediante los mandos de volante del coche.

Pulsar una de las funciones para iniciar la configuración (EJ. ) el Icono iniciará a parpadear, sucesivamente pulsar la tecla correspondiente en el volante.

Efectuar esta operación con todas las funciones presentes en el volante, y salir del menú de memorización del volante. Para resetear las funciones memorizadas y volver a realizar el emparejamiento pulsar el icono .

 10R05/01 2617 00

 DICHIARAZIONE DI CONFORMITÀ alla direttiva 2014/53/EU  
DECLARATION OF CONFORMITY directive 2014/53/EU

**IT** Phonocar dichiara che il VM002 è conforme ai requisiti essenziali e a tutte le altre disposizioni pertinenti stabilite dalla direttiva 2014/53/EU.

**EN** Phonocar declares that this unit VM002 is in compliance with the essential requirements and other relevant provisions of Directive 2014/53/EU.

**FR** Phonocar déclare que l'appareil VM002 est conforme aux exigences essentielles et aux autres dispositions pertinentes de la Directive 2014/53/EU.

**D** Phonocar erklärt, dass dieser VM002 in Übereinstimmung ist mit den grundlegenden Anforderungen und den anderen relevanten Vorschriften der Richtlinie 2014/53/EU.

**E** Phonocar declara que el VM002 cumple con los requisitos esenciales y cualesquiera otras disposiciones aplicables o exigibles de la Directiva 2014/53/EU.

 Il prodotto non deve essere smaltito con i rifiuti domestici. Si ricorda che le pile/accumulatori devono essere rimosse dall'apparecchiatura prima che questa sia conferita come rifiuto. Per rimuovere le pile/ accumulatori fare riferimento alle specifiche indicazioni del costruttore. L'utente dovrà, pertanto, conferire gratuitamente l'apparecchiatura e la pila giunta a fine vita agli idonei centri comunali di raccolta differenziata dei rifiuti elettrici ed elettronici, oppure riconsegnarle al rivenditore. L'adeguata raccolta differenziata contribuisce ad evitare possibili effetti negativi sull'ambiente e sulla salute e favorisce il reimpiego e/o riciclo dei materiali di cui essi sono composti. Per ulteriori informazioni consultare il sito [www.phonocar.it](http://www.phonocar.it)

*This product must NOT be treated as a domestic waste. Please remember that batteries/chargers must be extracted from the appliance before throwing the appliance away. How to extract batteries/chargers: please follow the manufacturer's specific instructions.*

*The end-user is requested to carry the appliance and its related battery, with no cost, to the municipal waste-recycling-spots for electrical and electronic parts, or take them to the related Retailer shop. Recycling-spots help to avoid negative effects on the environment & health and promote the re-use and/ or recycling of the various materials. For further information, please read homepage [www.phonocar.it](http://www.phonocar.it)*